

Affordable, luxurious,
easy fit solid surfaces

minerva[®]

FITTING PERFECTION

CARYSIL
SURFACES





minerva® Chalk Venato

Solid performance...

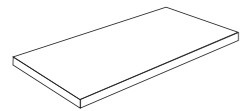

FACTORY MACHINED
FACE & EDGES, ALL
FINISHED BY HAND

All **minerva**® worksurfaces are supplied ready for installation with smooth factory machined face & edges all finished by hand.

No need, therefore, for time consuming and messy preparation work as face & edges are finished and ready for fitting.



FASTER LEAD TIMES,
QUICKER
INSTALLATION

minerva® cuts the wait and cost usually associated with choosing solid worksurfaces, saving you time and money.

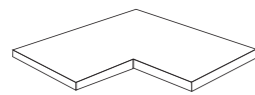

IMPERCEPTIBLE,
SEAMLESS,
SOLID JOINTS

Whether you are using the services of a professional installer or doing the job yourself, **minerva**® is designed to deliver the best possible aesthetic results.

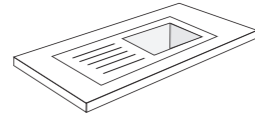

PRE-FABRICATED
FEATURES

Undermounted bowls teamed with designer drainer grooves, breakfast bars, splashbacks and upstands, these are just some of the added attractions of choosing **minerva**® for your kitchen.

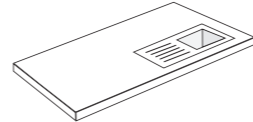

CUSTOM
SERVICE

Rather than fabricating on-site, bespoke worktops can be manufactured in our factory as per your unique kitchen designs.

...total design flexibility

minerva® solid worksurfaces are manufactured to a full 25mm thickness with colour throughout.

Welcome to **minerva**®: the home of practical and solid kitchen worksurface material, manufactured using state-of-the-art technology. Delivering a luxurious appearance, cool pleasing touch and robust performance day in, day out. With a 10-year guarantee against manufacturing defects, style is not compromised for quality.

Imperceptible, seamless joints with full design flexibility. Aspirations are a reality. Whether you dream of sweeping curves or contemporary lines, **minerva**® offers the flexibility to meet all your design needs without the cost of specialist installation. Please take a look through our brochure and contemplate some of the possibilities. Your imagination will provide the rest!

CARYSIL
SURFACES

In 2022 we became part of the Carysil group of companies – world renowned for manufacture of quality sinks, taps and now worksurfaces.



minerva Carrara White

Tap shown can be found in the Carysil Products range, visit carysil.co.uk

Factory machined face & edges, all finished by hand

All **minerva**® worksurfaces are supplied with smooth factory machined face and edges, all finished by hand

We cut and hand finish the worksurface face and edges for you, so they are delivered ready to fit, saving you valuable installation time and money.

No need to spend time on site making sure the finished face and edges are square and presentable, it's all been done for you.

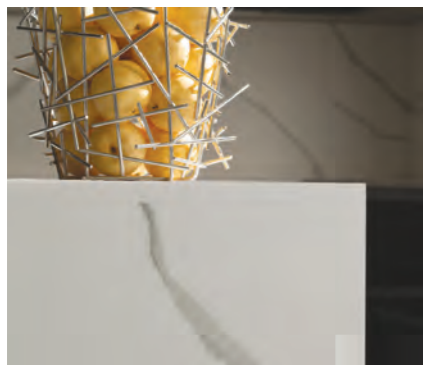
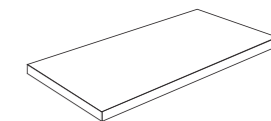

minerva Calcutta White



minerva Concrete Haze



minerva Ice Crystal

minerva®



minerva® Grey Crystal



minerva® Ice Crystal - stylish upstands are hygienic and easy to clean



minerva® Caramel Crunch - worksurfaces can be easily cut on-site to produce concave and convex curved corners



minerva® Marble Wash

Faster lead times... quicker installation

No specialist equipment, no specialist installation...no time wasted

With **minerva**® there is no waiting for complicated templates to be produced and risk expensive delays. All **minerva**® worksurfaces are factory machined and then finished by hand, delivered ready for installation...it's that quick, it's that simple.



The versatility of **minerva**® allows for any shape of your choice. Both concave and convex curved corners can be easily cut on-site with standard woodworking tools by any experienced kitchen fitter.

CARYSIL
SURFACES

minerva®



minerva® Ice Blue super large sink module
Tap shown can be found in the Carysil Products range, visit carysil.co.uk

minerva®



minerva White with upstand delivers clean flowing lines. Sink and tap shown can be found in the Carysil Products range, visit carysil.co.uk



minerva Silver Haze with granite undermount sink module. Tap shown can be found in the Carysil Products range, visit carysil.co.uk



minerva Carrara White is a veined décor reflecting the natural appeal of stone



minerva Peak Stone with the cool touch of solid stone



minerva Sparkling White is reassuringly elegant with just the right amount of sparkle

Imperceptible, seamless, solid joints

Smooth flowing lines, even across the joint

Every **minerva** joint is hygienic and seamless to touch. An imperceptible joint can be achieved with most décors. Our veined décors are completely unique, therefore visual difference between joints is to be expected.

There are no specialist preparation procedures required to achieve beautiful imperceptible, seamless joints

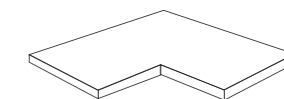

minerva[®]

minerva® Carrara White with pre-fabricated 1.5 bowl acrylic sink



minerva® Ice Blue



minerva® Silver Haze

Pre-fabricated features

With fabrication built-in, **minerva®** saves valuable time when it comes to preparation and installation

All working faces and edges are factory machined and hand finished, which means there's no time wasted on site. Select an undermounted steel or acrylic sink from the **minerva®** collection.

Factory pre-fabricated for easy and quick installation.



minerva® Grey Storm

minerva® sink modules are made from a solid piece of material, the recessed sections may have a slightly different pattern on some décors due to the spread of the coloured chips.

Due to the production process of **minerva®** Copper Fleck worksurfaces, the particulate can be felt in the finished surface giving it a textured feel. This is quite normal and does not affect the use of the worksurface.



minerva® Copper Fleck

minerva®



Steel 25mm internal radius undermount sinks

This is our original range of undermounted steel sinks with a 25mm corner radius. These sink modules have a recessed area around the sink cut out and include drainer grooves.

- 25mm radius corners
- Boiling tap compatible
- Plumbing kit supplied
- Fitting clips & sealant supplied



Steel 10mm internal radius undermount sinks

For a more contemporary feel look no further than our 10mm radius steel undermounts. The tighter 10mm radius and pressed drainer channels give a clean modern feel and the simple drainer groove finish allows for the tap to be located to your own requirements.

- 10mm radius corners
- Boiling tap compatible
- Plumbing kit supplied
- Fitting clips & sealant supplied





Single bowl   

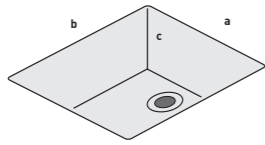

a. 340mm
b. 400mm
c. 190mm



Super large bowl   



a. 480mm
b. 400mm
c. 200mm

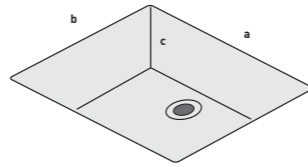



Single bowl   

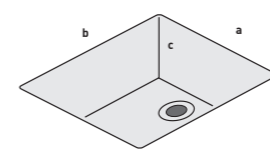

a. 340mm
b. 400mm
c. 190mm





Super large bowl   

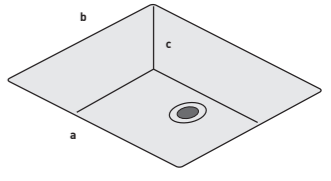

a. 410mm
b. 400mm
c. 190mm





1.5 Duo bowl   

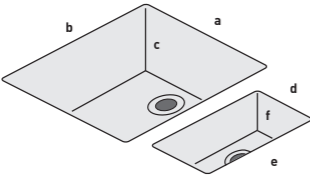

a. 340mm
b. 400mm
c. 190mm
d. 160mm
e. 300mm
f. 120mm





1.5 Designer bowl   

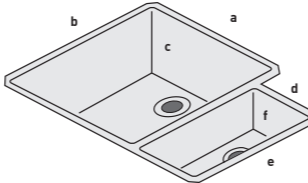

a. 340mm
b. 400mm
c. 190mm
d. 160mm
e. 300mm
f. 120mm



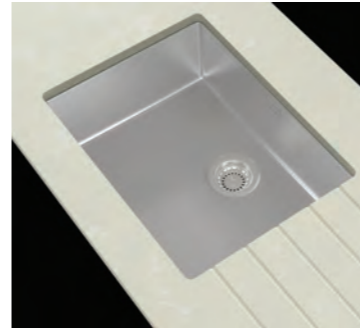

Ultra large bowl   

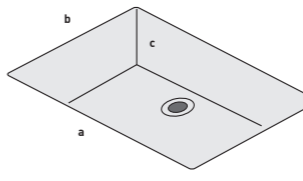

a. 550mm
b. 400mm
c. 190mm





1.5 Duo bowl   

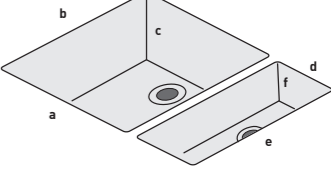

a. 340mm
b. 400mm
c. 190mm
d. 180mm
e. 400mm
f. 125mm



1.5 Designer bowl   

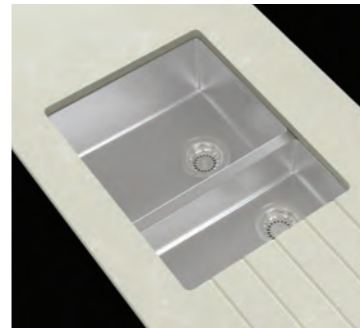



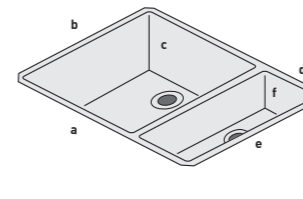

a. 550mm
b. 400mm
c. 190mm
d. 180mm
e. 400mm
f. 125mm



All **minerva** sink modules are supplied as either left or right hand bowl which must be specified at the time of order. Images shown are left hand bowl. All steel and acrylic bowls are suitable for use with waste disposal units. Only steel and granite bowls are suitable for use with instant hot water taps. Whilst **minerva** sink modules are made from a solid piece of material, the recessed sections may have a slightly different pattern on some décors due to the spread of the coloured chips. Our acrylic bowls aren't suitable for use with boiling water taps. Allowing boiling water to run freely into acrylic bowls over a period of time may result in superficial crazing of the acrylic surface. When straining boiling water from vegetables etc. we recommend you always run the cold water tap to help prolong the quality of the sink.

KEY:

-  This sink is suitable for use with a boiling water tap
-  Will fit into 500mm base cabinet
-  Will fit into 600mm base cabinet
-  Will fit into base cabinet openings over 650mm
-  All bowls are SS304 (18/10) grade steel

minerva[®]

Granite undermount sinks

Our granite undermount selection offers great durability and a simple uncluttered design. Add the choice of 4 colourways and the options are plentiful.

- 12mm radius corners
- Boiling tap compatible
- Plumbing kit supplied
- Fitting clips supplied



Acrylic 25mm undermount sinks

Our 25mm acrylic sink modules are supplied with a seamless, factory fitted, white sink. Each module has a recessed drainer area and drainer grooves machined into the surface and then hand finished by our highly skilled fabricators.

- 25mm radius corners
- NOT compatible with boiling water taps
- Plumbing kit supplied
- Fully fabricated at our factory



Single bowl



a. 400mm
b. 400mm
c. 200mm

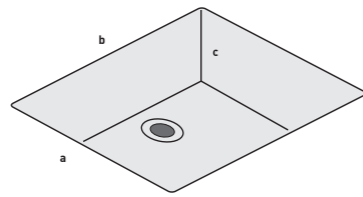

Single bowl

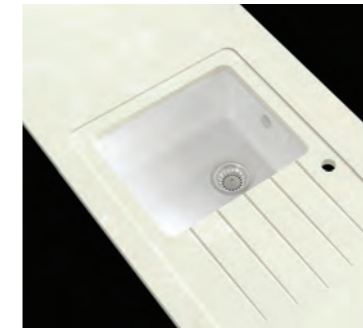

a. 340mm
b. 400mm
c. 190mm

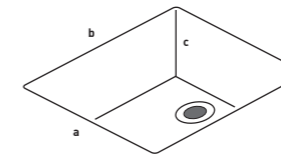

Super large bowl

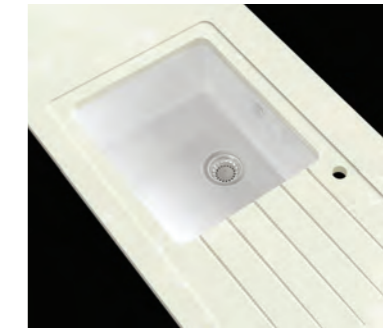

a. 480mm
b. 400mm
c. 200mm

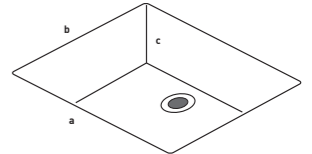

Super large bowl

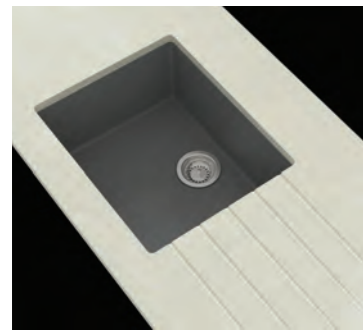

a. 500mm
b. 400mm
c. 200mm

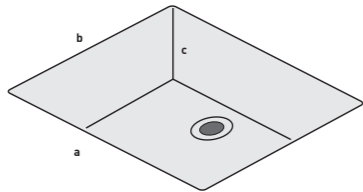

1.5 Duo bowl



a. 340mm
b. 400mm
c. 190mm
d. 160mm
e. 300mm
f. 120mm

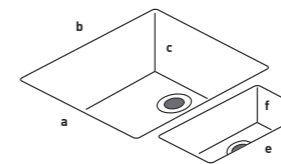

1.5 Designer bowl



a. 340mm
b. 400mm
c. 190mm
d. 160mm
e. 300mm
f. 120mm

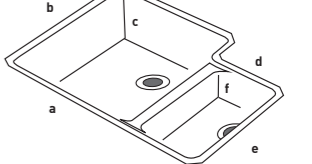

1.5 Designer bowl

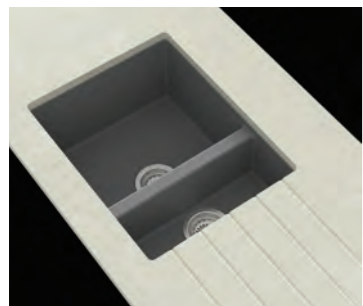

a. 335mm
b. 400mm
c. 200mm
d. 155mm
e. 400mm
f. 140mm

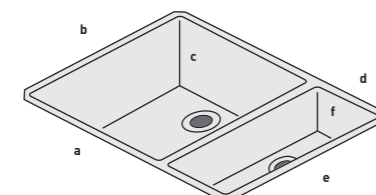

Available in the following colours



Black



White



Gunmetal



Graphite

1.5 Duo only available with left hand bowl as shown

minerva®

Integrated sinks

The ultimate sink module is here! For the ultimate in luxury our integrated sink has sides formed from minerva surface material to give the perfect match. Paired with a steel bowl in a choice of four finishes you can make this the centrepiece of your new kitchen.

- Plumbing kit supplied
- Fully fabricated at our factory
- Boiling tap compatible



Large bowl   



a. 400mm
b. 370mm
c. 210mm

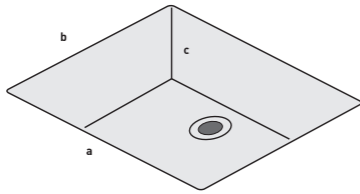

Available in the following colours



Copper





Gold/Brass



Gunmetal





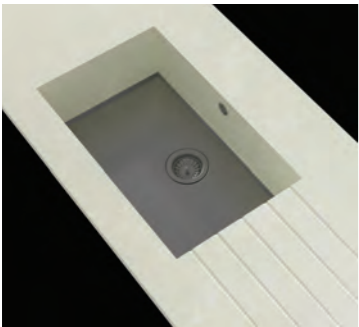

Steel

Ultra large bowl   

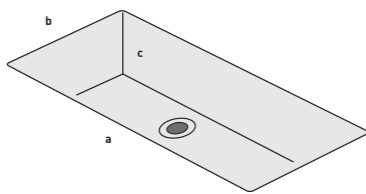

a. 630mm
b. 370mm
c. 210mm



1.5 Duo bowl   

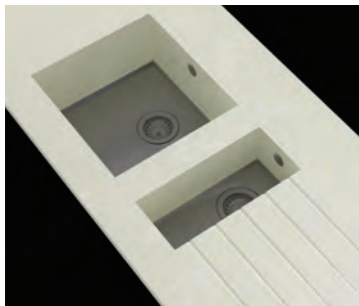

a. 400mm d. 160mm
b. 370mm e. 370mm
c. 210mm f. 155mm

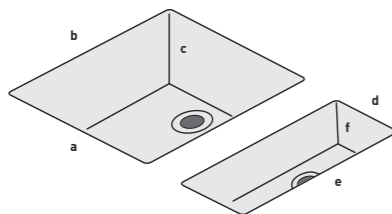

CARYSIL

minerva[®] Calcutta White
Tap shown can be found in the
Carysil Products range, visit carysil.co.uk

minerva[®]

minerva® décor collection

*Each of these worksurfaces are unique, reflecting the natural appeal of marble and stone.

Whilst **minerva**® sink modules are made from a solid piece of material, the recessed sections may have a slightly different pattern on some décors due to the spread of the coloured chips. Due to the nature of the particulate used in producing **minerva**® Copper Fleck solid worksurfaces, it is possible that some slight unevenness may be felt in the finished surface. This added texture is quite normal and does not affect the use of the worktop.



minerva® Calcutta White* (CT)
Price Group 4



minerva® Travertine Haze* (TH)
Price Group 3
(Veined décor)



minerva® Silver Haze* (SH)
Price Group 3
(Veined décor)



minerva® Concrete Haze* (CH)
Price Group 3
(Veined décor)



minerva® Ice Crystal (IC)
Price Group 2



minerva® Caramel Crunch (CC)
Price Group 2



minerva® Peak Stone (PS)
Price Group 2



minerva® White (WH)
Price Group 1



minerva® Nimbus Grey (NG)
Price Group 2

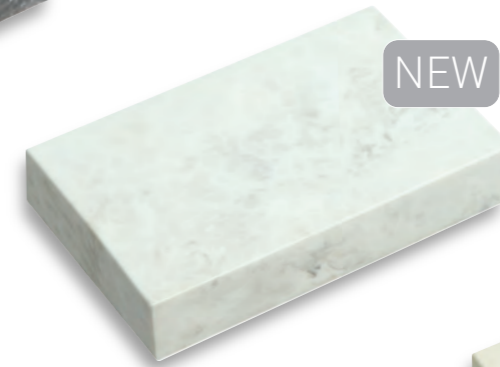

minerva® Marble Wash* (MW)
Price Group 3
(Veined décor)



minerva® Grey Crystal (GC)
Price Group 2



minerva® Chalk Venato* (CV)
Price Group 3
(Veined décor)

minerva® Sparkling White (SW)
Price Group 3



minerva® Carrara White* (CA)
Price Group 3
(Veined décor)



minerva® Grey Storm* (GS)
Price Group 3
(Veined décor)



minerva® Blue Venato* (BV)
Price Group 3
(Veined décor)



minerva® Ice Blue (IB)
Price Group 2



minerva® Copper Fleck (CF)
Price Group 3

Price Group 1 (WH) White

Price Group 2 (IC) Ice Crystal, (IB) Ice Blue, (PS) Peak Stone, (NG) Nimbus Grey, (GC) Grey Crystal, (CC) Caramel Crunch,

Price Group 3 (CA) Carrara White*, (CF) Copper Fleck, (SW) Sparkling White, (SH) Silver Haze*, (CH) Concrete Haze*, (TH) Travertine Haze* (MW) Marble Wash*, (GS) Grey Storm*, (CV) Chalk Venato* (BV) Blue Venato*

Price Group 4 (CT) Calcutta White*

Standard range & sizes

Worksurfaces

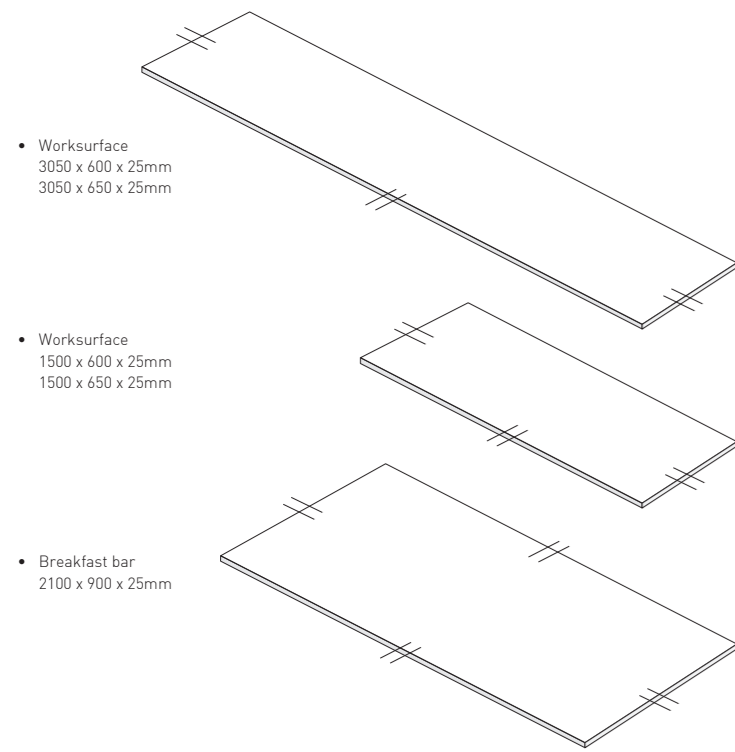

Splashbacks & upstands

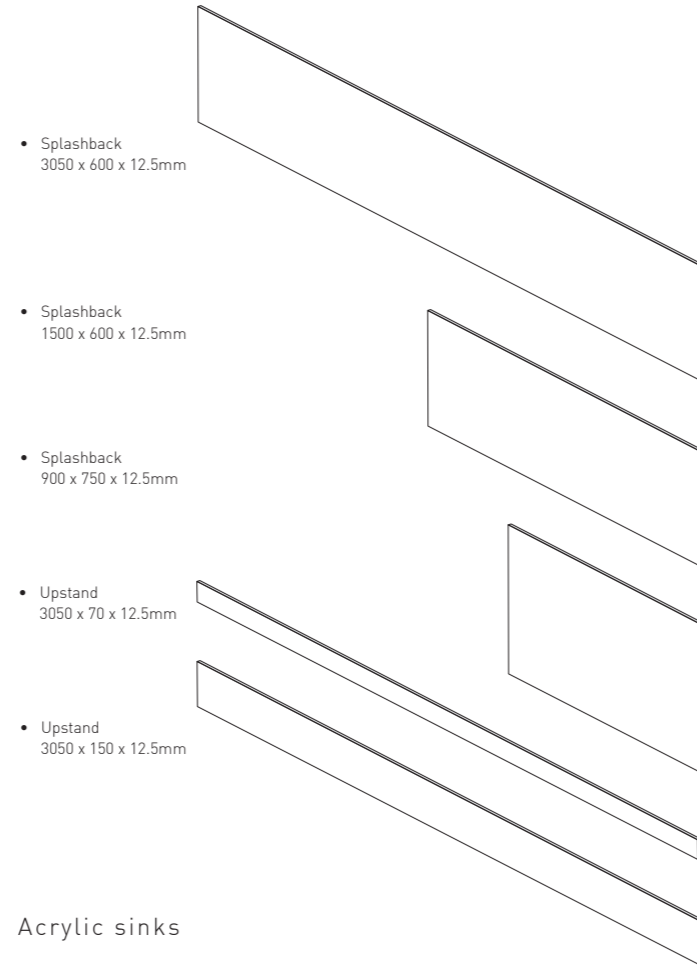

Sink Modules

Steel 25mm internal radius undermount sinks

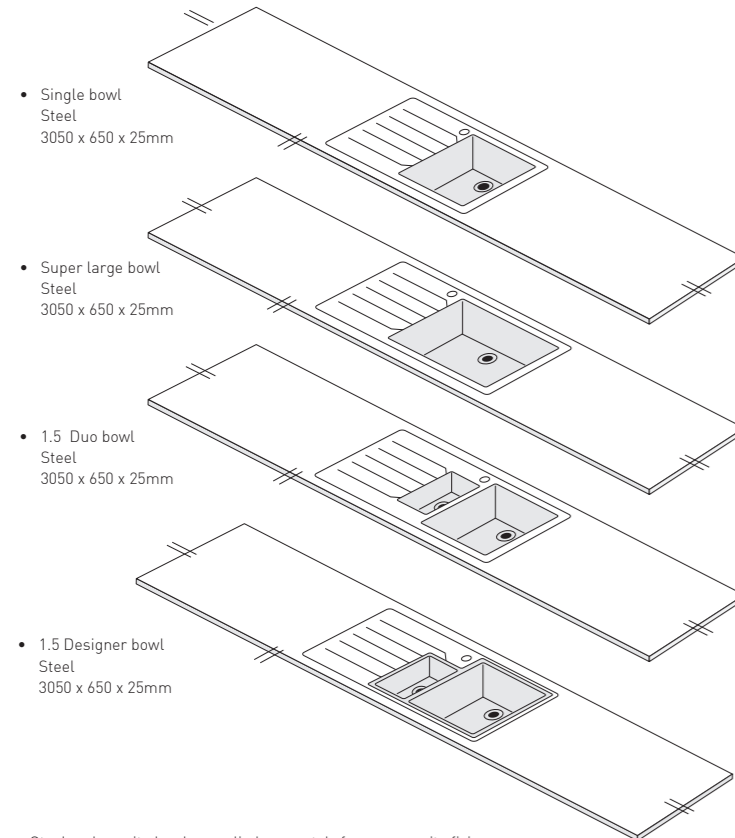

Acrylic sinks

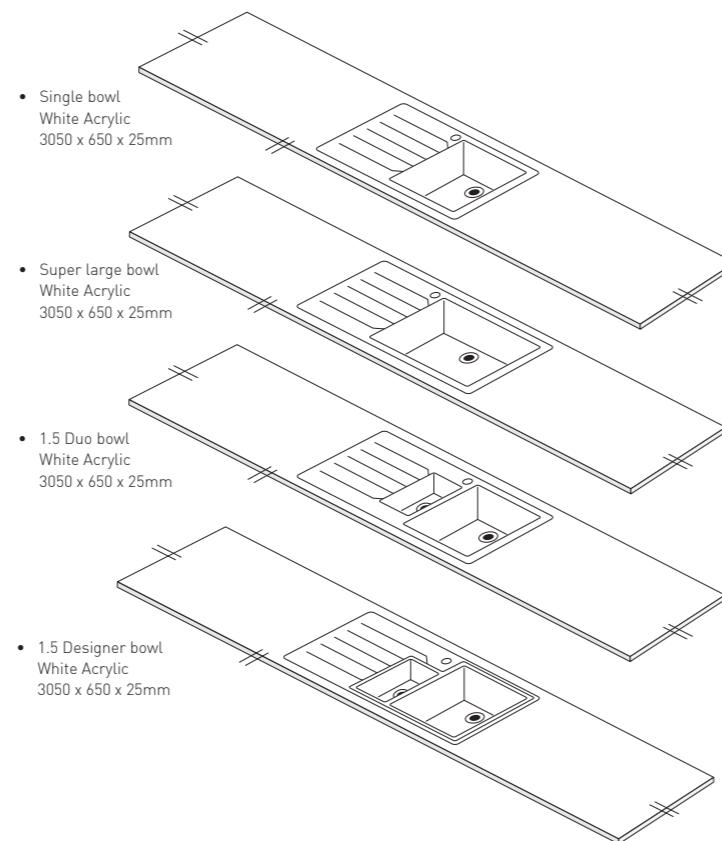

- Steel and granite bowls supplied separately for easy on site fixing
- Acrylic and integrated bowls are factory fitted
- All décors are available in these sizes as standard

||| Factory finished edge — Unfinished edges

Steel 10mm internal radius undermount sinks

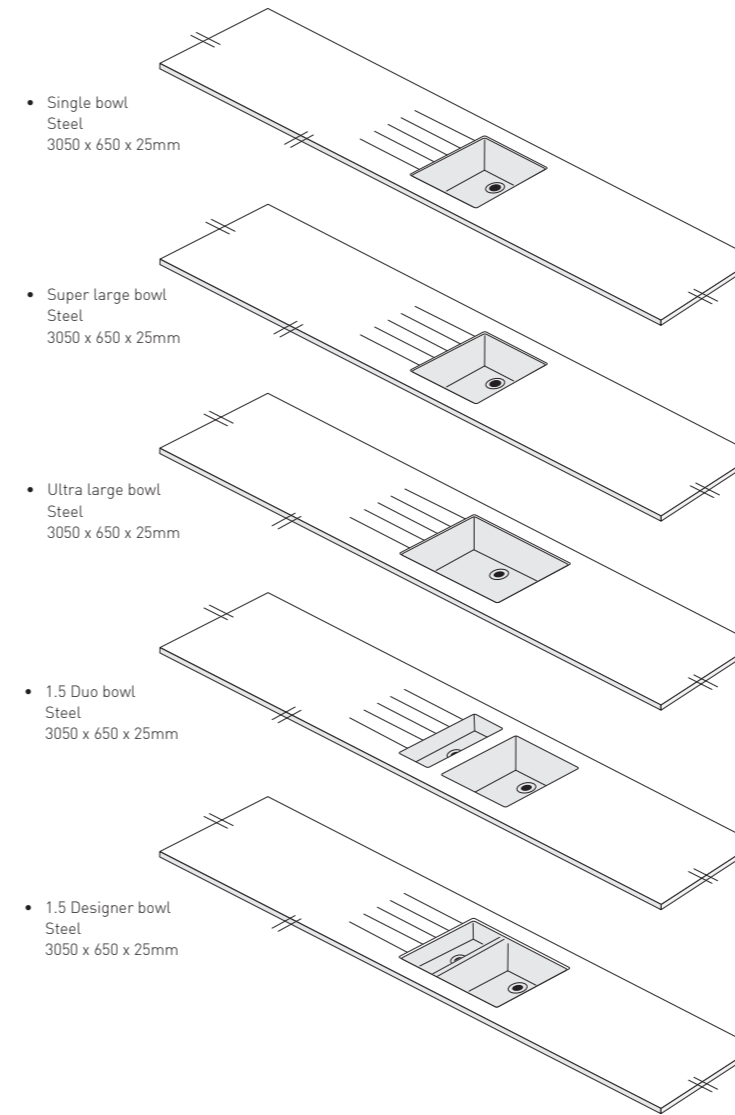

Granite undermount sinks

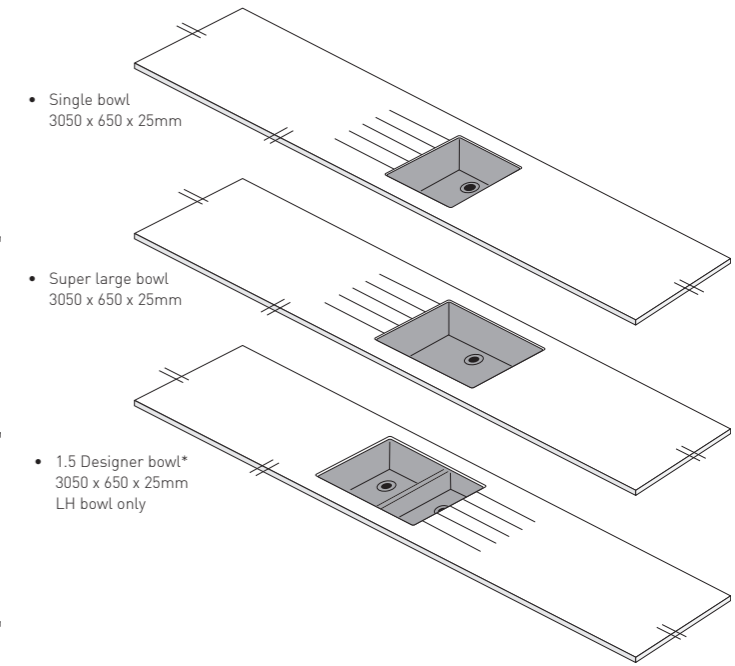

||| Factory finished edge — Unfinished edges

* All sink modules are available with LH or RH main bowl except Granite 1.5 Designer bowl

Integrated Sinks

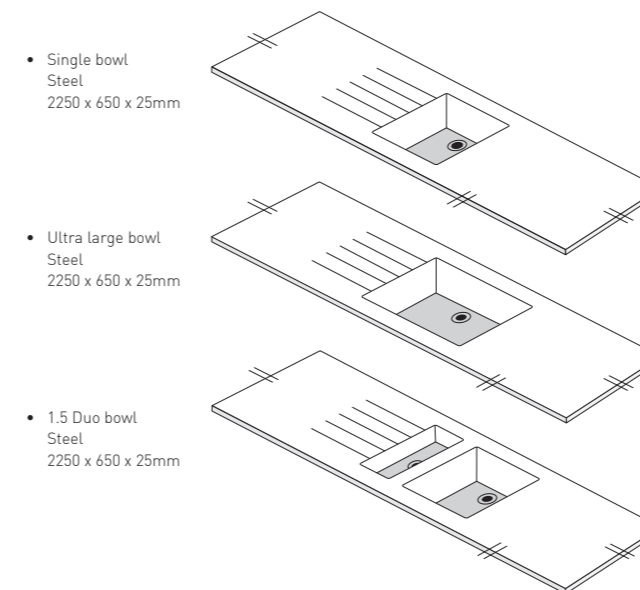



Islands & breakfast bars

Due to the continuing investment in our production processes, we are now able to offer larger islands and breakfast bars in some décors as standard items. This can save further time on site and with Calcutta, for instance, the full veined effect can run across your feature island.

- Island
3050 x 1240 x 25mm*

- Breakfast bar
3050 x 940 x 25mm*

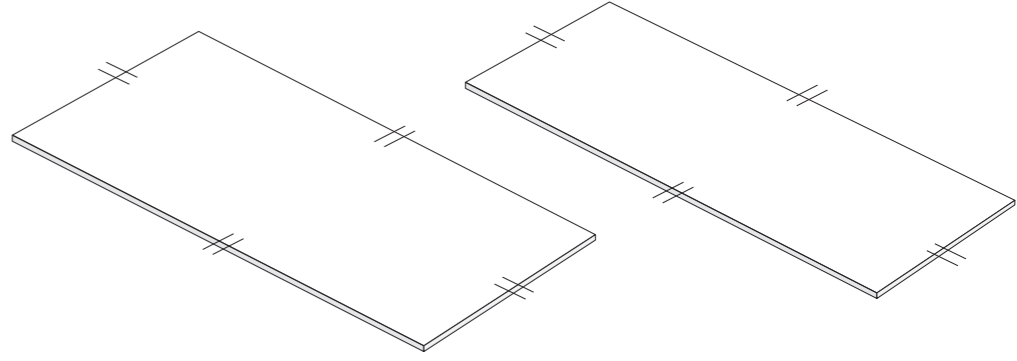

|| Factory finished edge

* sizes unique to Calcutta White only



minerva® Carrara White with integrated sink module. Tap shown can be found in the Carysil Products range, visit carysil.co.uk

- Island
2480 x 1240 x 25mm

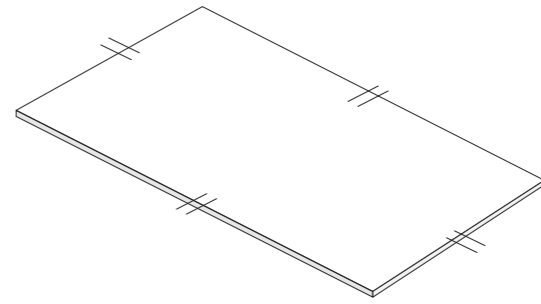

Available in:
 White | Sparkling White
 Ice Crystal | Copper Fleck
 Carrara White | Grey Crystal
 Calcutta White

|| Factory finished edge

minerva®



minerva® Ice Blue



minerva® Sparkling White - hob cut-outs are prepared easily on-site making larger size island worktops ideal for food preparation and meal times



minerva® Nimbus Grey



minerva® Carrara White - edge detail can completely change the appearance of a worktop

Custom service

Your kitchen should be everything you've dreamed of

Our Custom Service department specialises in producing the extraordinary.

Rather than fabricating on-site, bespoke worktops can be manufactured in our factory as per your unique kitchen designs... we call it Custom Service.

All of our **minerva**® sinks and drainer grooves are located centrally within the standard sink module. With Custom Service, we can locate your sink and drainer grooves anywhere, often to the far left or far right of the worktop.

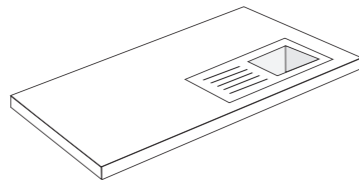

minerva® solid surfaces come with our 10 year guarantee* and are supported by the FIRA Gold Award for product excellence – this is testimony to the fact that we use only the most superior materials and our products are constantly tested to ensure they are manufactured to the highest standards.



minerva® has been developed for the domestic environment, especially the kitchen. Although no 'special' maintenance is needed, we recommend the following is adhered to, as prevention is always better than cure.



Routine cleaning

minerva® does not require any specialist cleaning regimes, most dirt and light residue will easily wipe off with a damp cloth and soapy water. The worksurface should then be rinsed with clean water and wiped dry. Persistent marks can be removed by using a mild abrasive cleaner, but harsh scouring powders should be avoided. If in doubt, consult our care and maintenance guide.



Heat

minerva's surface will withstand heat better than many alternative surface materials. However, all hot pots, pans and other heat generating devices should always be placed on a trivet or worktop protector rods to prevent extreme heat having prolonged and direct contact with the surface. Boiling water and cooking splashes do not harm the surface.



Staining

minerva®, unlike marble and granite, is not porous and will resist most household chemicals including alcohol and cosmetics, however, some chemicals and strong dyes can cause damage and discolouration. If spillage occurs, wipe off immediately and rinse area thoroughly.



Standard woodworking tools

minerva® can easily be cut on site ready for jointing using standard woodworking tools and equipment.

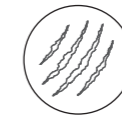

Minor scratching

Kitchen utensils and crockery (particularly unglazed bases) can sometimes cause scratches that will be more evident on darker colours. The surface can be damaged by scratching or cutting with knives, so the use of a cutting board is essential. Any minor scratches can easily be removed using the grey abrasive pad and other items from the **minerva**® care kit. Please refer to the care and maintenance guide.



minerva® care kit

To help maintain your **minerva**® worksurface, a care kit is available from your retailer. This kit contains all you need to make minor repairs to the surface and a special cleaner that helps to maintain, protect and build up lustre, particularly on darker colours.



Our commitment to customer service

When you choose **minerva**® you do so secure in the knowledge that you are buying a proven, reliable product; a product that is truly at the forefront of modern worksurface technology.

Our Customer Care department is on hand to offer you help, support and advice all year round.

Call: 01773 521 300

*Guarantee covers manufacturing not installation. In order to validate this warranty, the registration form included within each product must be completed and returned. Alternatively you can register your warranty online at www.minervawarranty.co.uk

Accessories

- **minerva**® jointing kit (75ml adhesive sachet, sanding discs and grey abrasive pad to finish)
- Individual 75ml adhesive sachet
- Installation, care and maintenance DVD
- Stainless steel finish worktop protector rods (pack of 6)



- **minerva**® care kit (countertop cleaner, ergonomic foam sanding pad, microfibre cleaning cloth, 2x 320 grit sanding discs and grey abrasive pad)

Quality assured

- ✓ Barcol Hardness - EN59
- ✓ Light Fastness - ISO 4892
- ✓ Fungal Resistance - EN ISO 846
- ✓ Food Safety - EN V 1186
- ✓ Bacterial Resistance - EN ISO 846
- ✓ Exposure to Dry Heat - EN 438-2.8

minerva®

minerva®



minerva® Blue Venato



minerva® Chalk Venato



minerva® Marble Wash



minerva® Grey Storm

CARYSIL
SURFACES

Azalea Close Clover Nook Industrial Park
Alfreton Derbyshire DE55 4QX

t 01773 521 300 e sales@minervaworksurfaces.co.uk www.minervaworksurfaces.co.uk



minerva® is a registered trademark of Carysil Surfaces Limited. Copyright © Carysil Surfaces Limited 2023

Disclaimer: Colours are as accurate as the printing process allows. As part of a process of on-going innovation, we reserve the right to change specifications without prior notice.